

ASSEMBLY INSTRUCTION

ZANE 5PCS SET

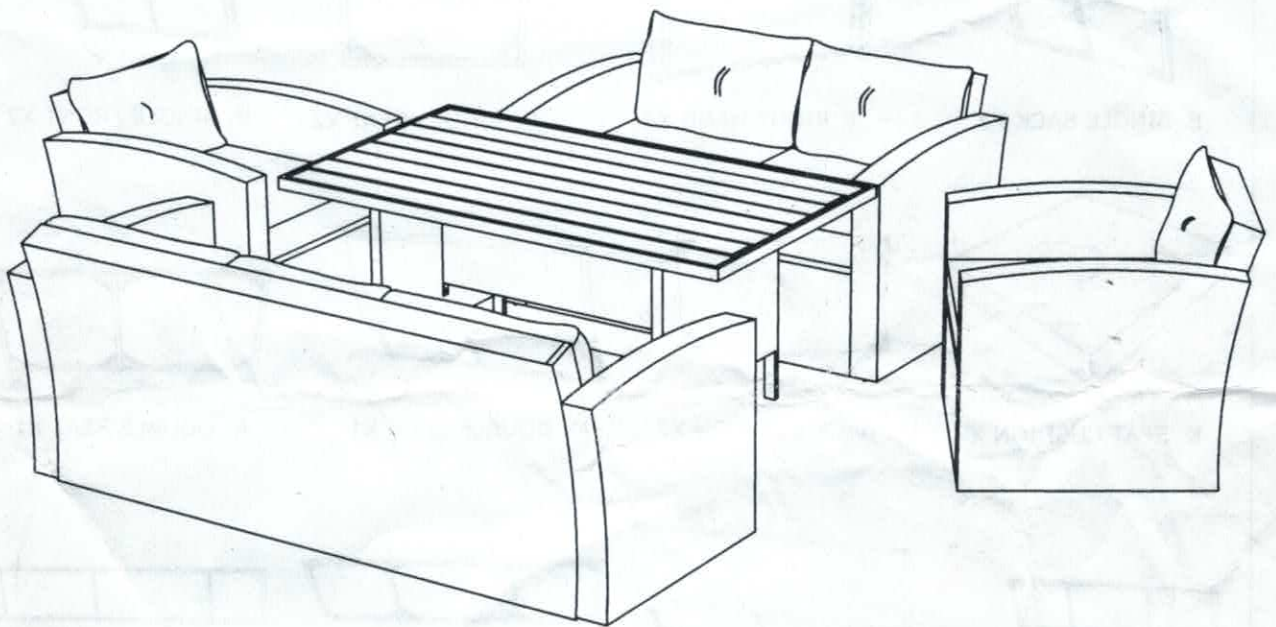

COMPONENTS



A. TABLE TOP X1



B. TABLE LEG X2

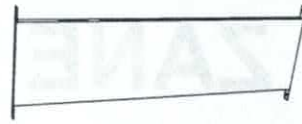

C. TABLE BRACER X1

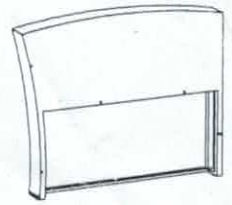

D. LEFT HAND X4

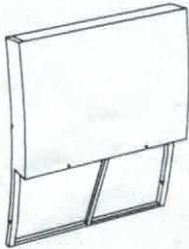

E. SINGLE BACK X2

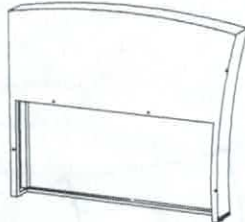

F. RIGHT HAND X4

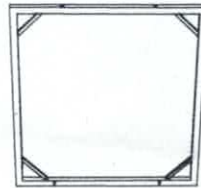

G. SINGLE SEAT X2

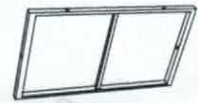

H. SINGLE FRONT X2

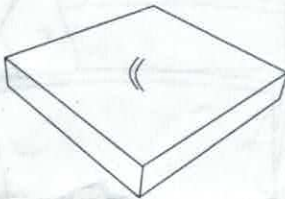

K. SEAT CUSHION X7



L. BACK CUSHION X7

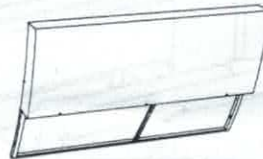

M. DOUBLE BACK X1

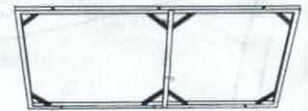

N. DOUBLE SEAT X1

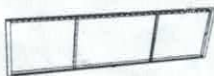

O. DOUBLE FRONT X1

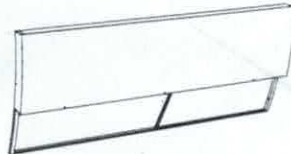

P. TRIPLE BACK X1



Q. TRIPLE SEAT X1



R. TRIPLE FRONT X1

HARDWARES



Bolt M6x40mm = 53 pcs



Bolt M6x30mm = 11 pcs



Bolt M6x20mm = 4 pcs



Washer = 68 pcs



Allenkey = 2 pcs

BOX 1/3

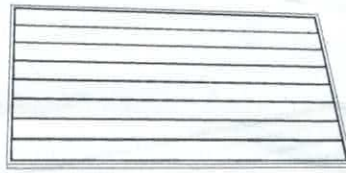

A. TABLE TOP X1

BOX 2/3

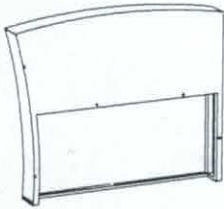

D. LEFT HAND X4

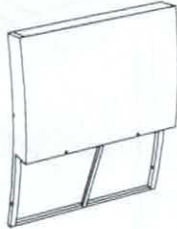

E. SINGLE BACK X1



F. RIGHT HAND X4

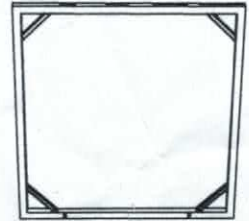

G. SINGLE SEAT X2

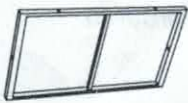

H. SINGLE FRONT X2

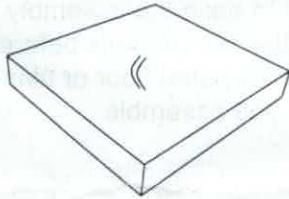

K. SEAT CUSHION X7

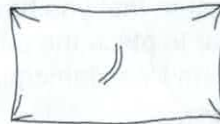

L. BACK CUSHION X1

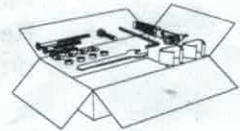

Hardware

BOX 3/3

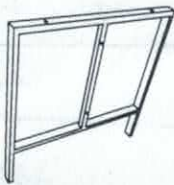

B. TABLE LEG X2

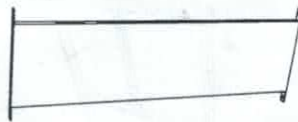

C. TABLE BRACER X1

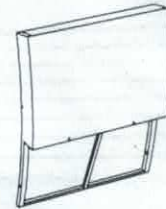

E. SINGLE BACK X1



L. BACK CUSHION X6

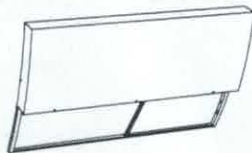

M. DOUBLE BACK X1

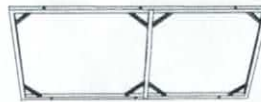

N. DOUBLE SEAT X1



O. DOUBLE FRONT X1

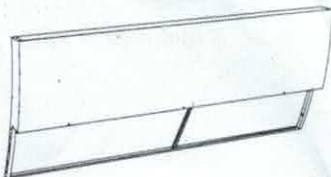

P. TRIPLE BACK X1



Q. TRIPLE SEAT X1



R. TRIPLE FRONT X1

ASSEMBLY INSTRUCTION



TABLE X1

These instructions must be used to ease the assembly of your furniture. Please ensure that you have all the components before assembly. Remember to place the part on a carpeted floor or blanket in order to protect them from damage while you assemble.

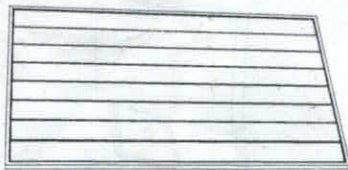

A. TABLE TOP X1



B. TABLE LEG X2



C. TABLE BRACER X1



② Bolt M6x30mm = 4pcs

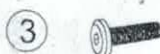

③ Bolt M6x20mm = 4pcs



④ Washer = 4pcs



⑤ Allenkey = 2pcs

Step 1:

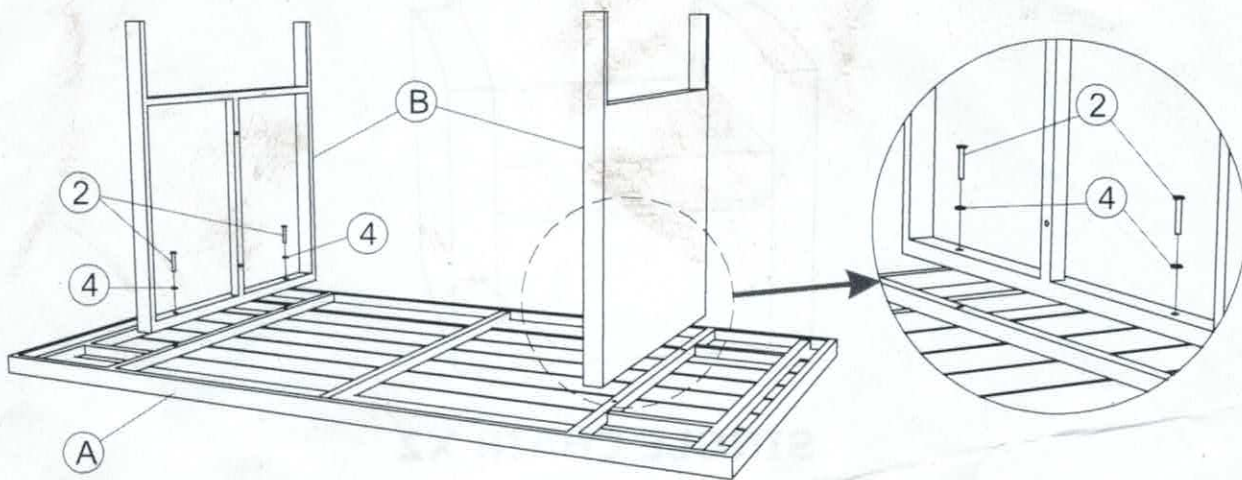

Step 2:

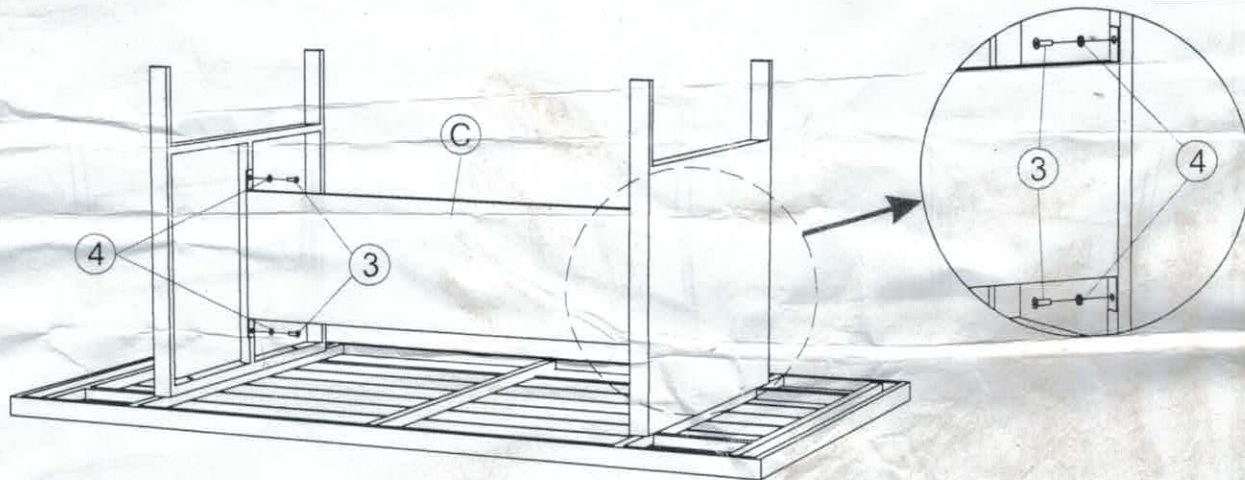

Finish



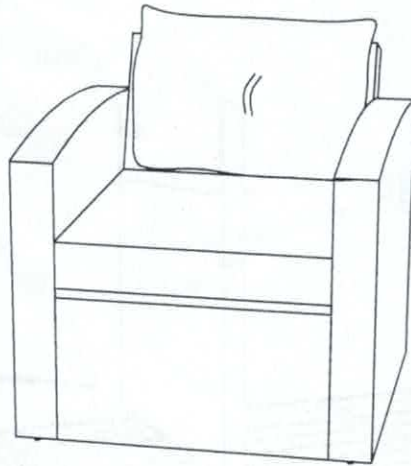

SINGLE CHAIR X2

These instructions must be used to ease the assembly of your furniture. Please ensure that you have all the components before assembly. Remember to place the part on a carpeted floor or blanket in order to protect them from damage while you assemble.

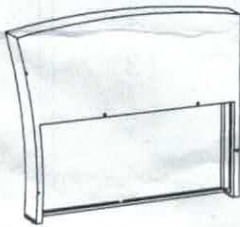

D. LEFT HAND X1



E. SINGLE BACK X1

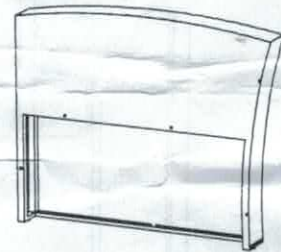

F. RIGHT HAND X1

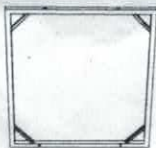

G. SINGLE SEAT X1



H. SINGLE FRONT X1

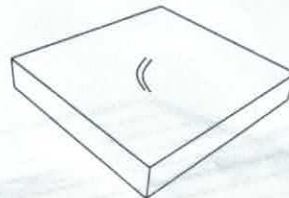

K. SEAT CUSHION X1

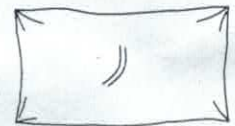

L. BACK CUSHION X1



Bolt M6x40mm = 12pcs



Bolt M6x30mm = 2pcs



Washer = 14pcs



Allenkey = 2pcs

Step 1:

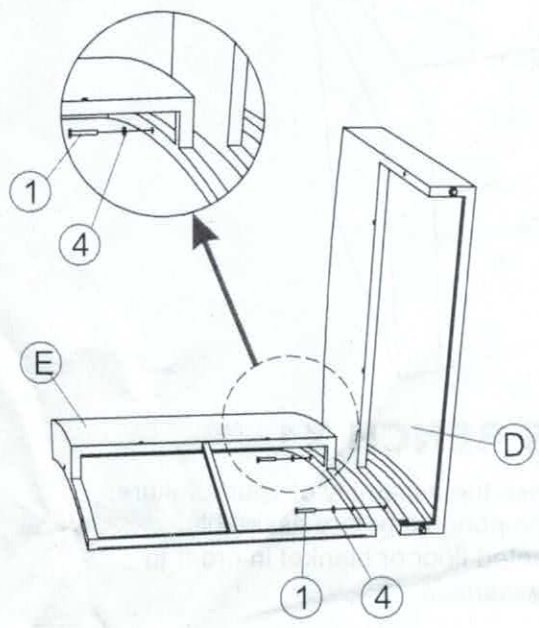

Step 2:

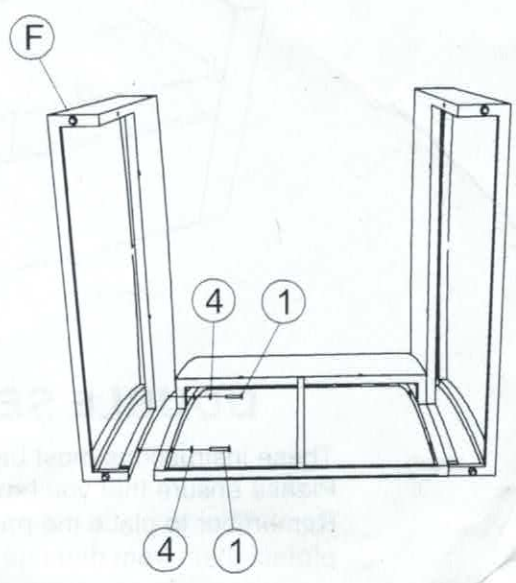

Step 3:

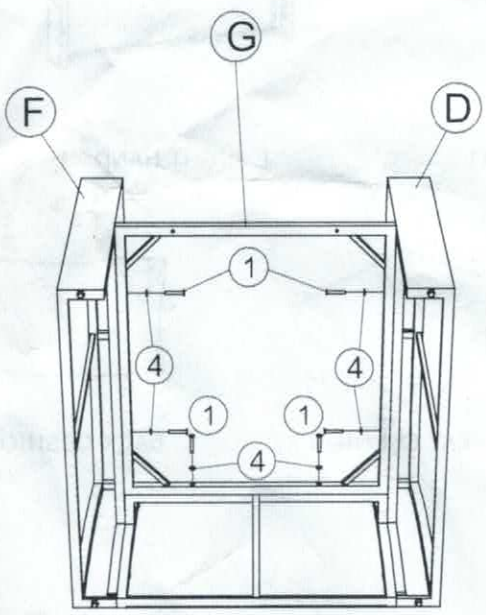

Step 4:

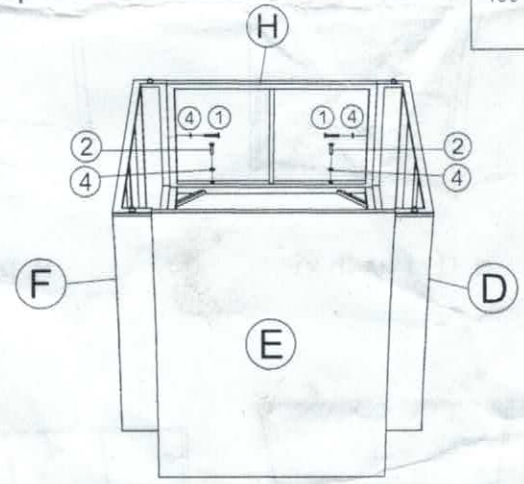

Finish

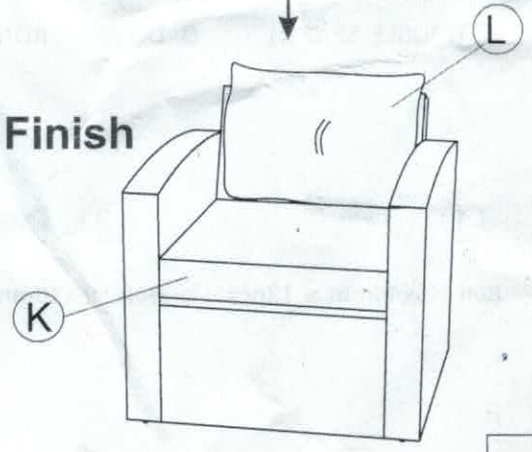

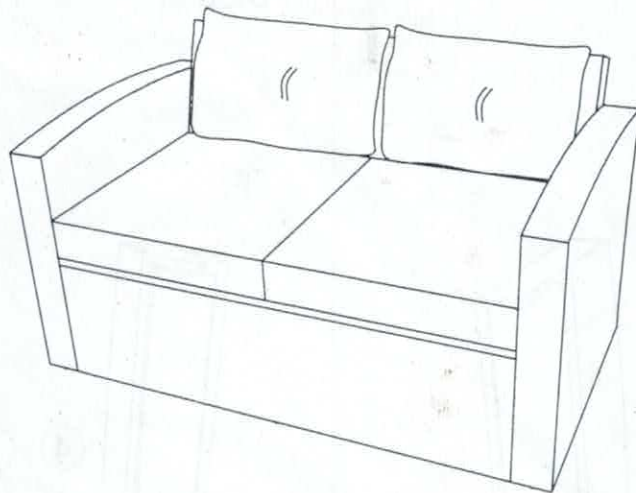

DOUBLE SEATERS BENCH X1

These instructions must be used to ease the assembly of your furniture. Please ensure that you have all the components before assembly. Remember to place the part on a carpeted floor or blanket in order to protect them from damage while you assemble.

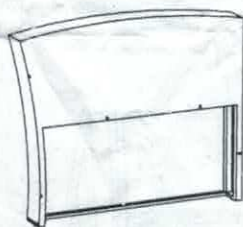

D. LEFT HAND X1

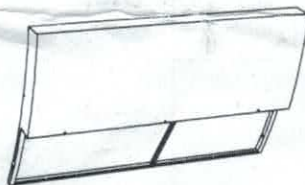

M. DOUBLE BACK X1



F. RIGHT HAND X1

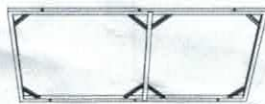

N. DOUBLE SEAT X1



O. DOUBLE FRONT X1

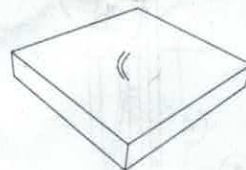

K. SEAT CUSHION X2

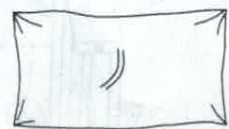

L. BACK CUSHION X2



Bolt M6x40mm = 13pcs



Bolt M6x30mm = 3pcs

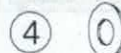

Washer = 16pcs



Allenkey = 2pcs

Step 1:

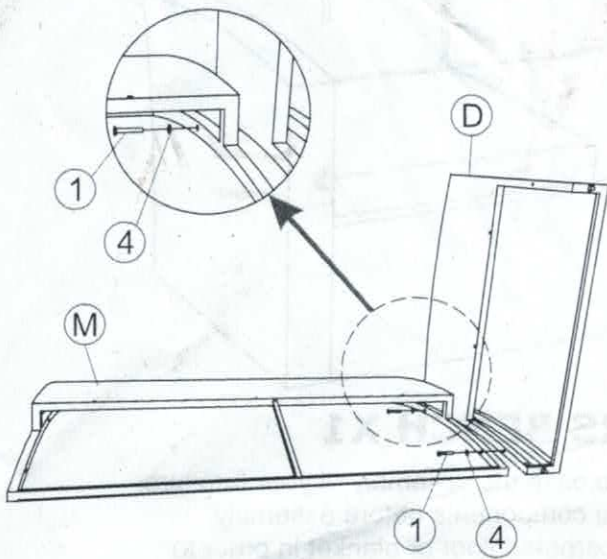

Step 2:

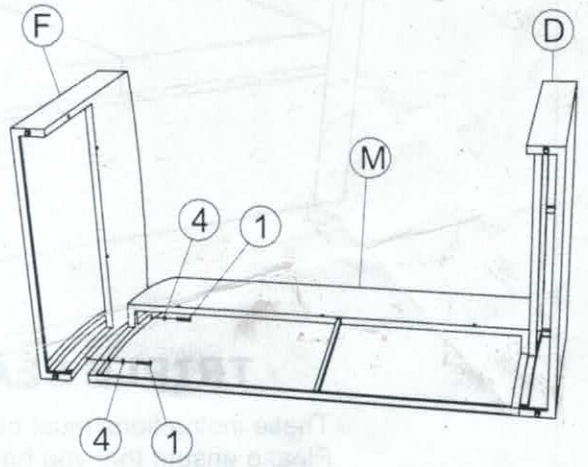

Step 3:

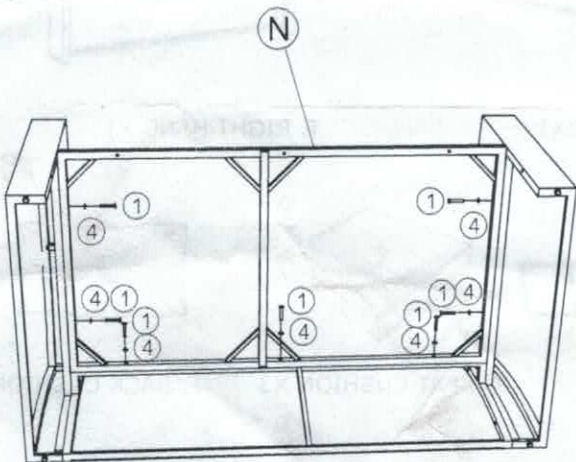

Step 4:

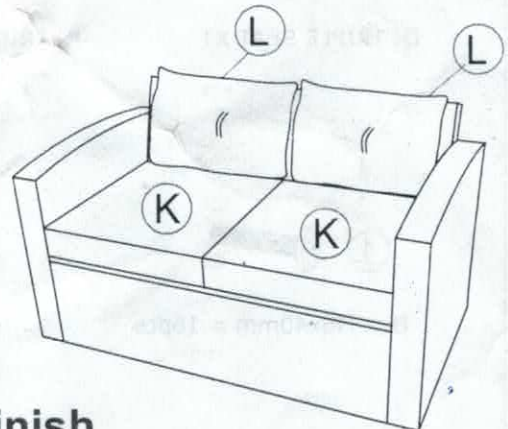
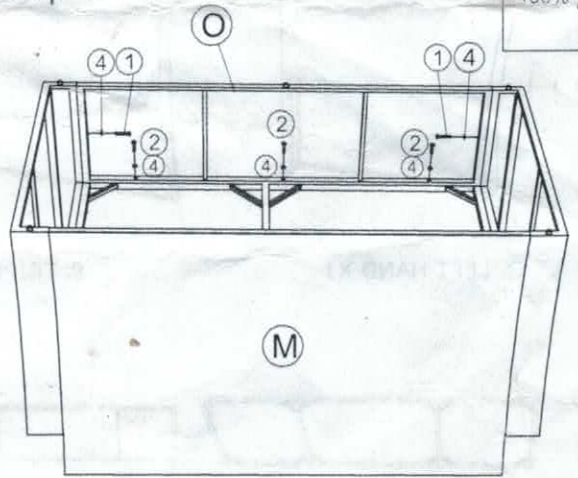

Finish

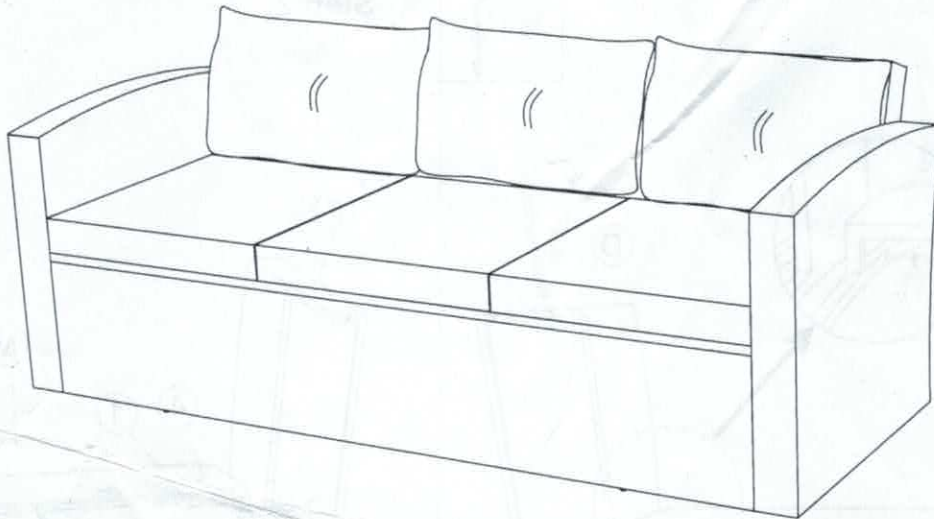

TRIPLE SEATERS BENCH X1

These instructions must be used to ease the assembly of your furniture. Please ensure that you have all the components before assembly. Remember to place the part on a carpeted floor or blanket in order to protect them from damage while you assemble.

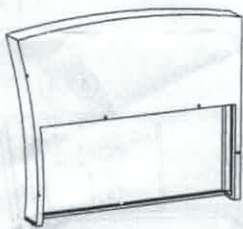

D. LEFT HAND X1

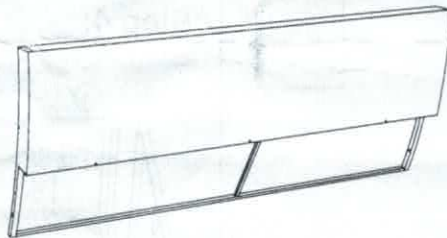

P. TRIPLE BACK X1

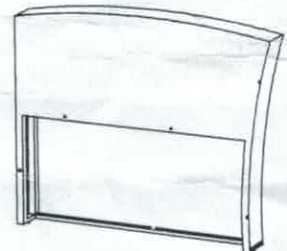

F. RIGHT HAND X1



Q. TRIPLE SEAT X1



R. TRIPLE FRONT X1



K. SEAT CUSHION X3



L. BACK CUSHION X3



Bolt M6x40mm = 16pcs

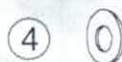

Washer = 16pcs



Allenkey = 2pcs

Step 1:

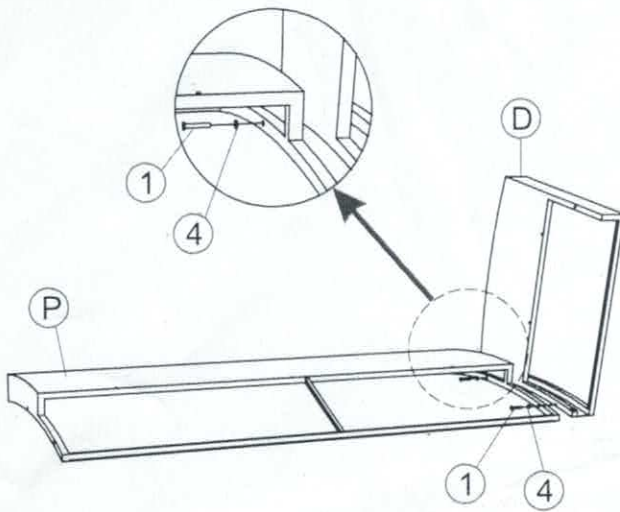

Step 2:

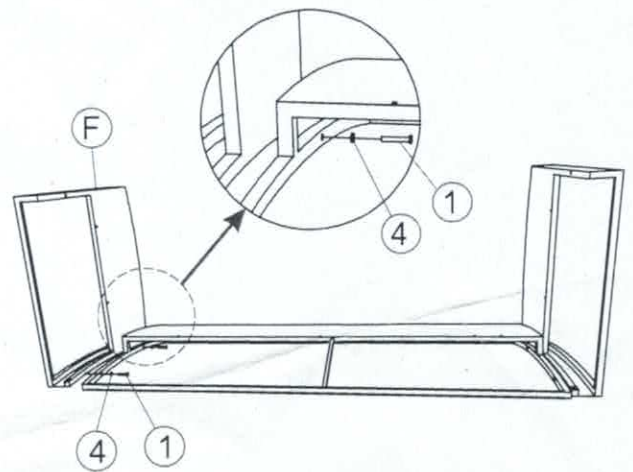

Step 3:

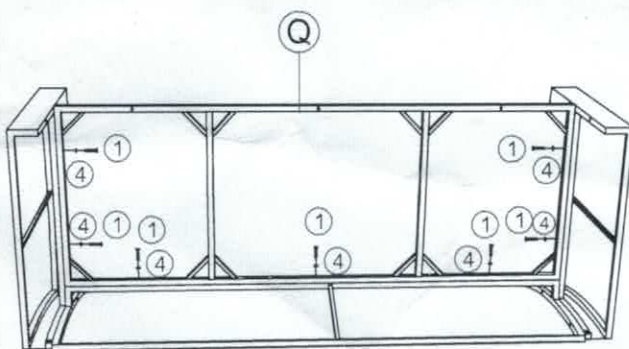

Step 4:

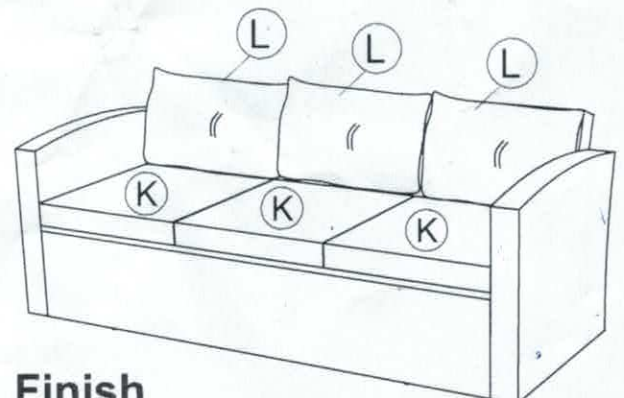
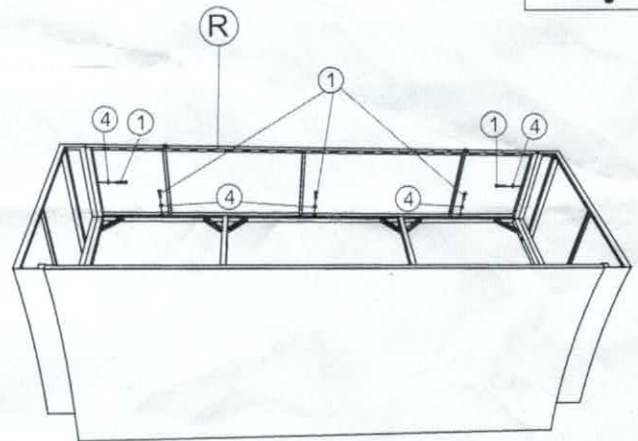

Finish