

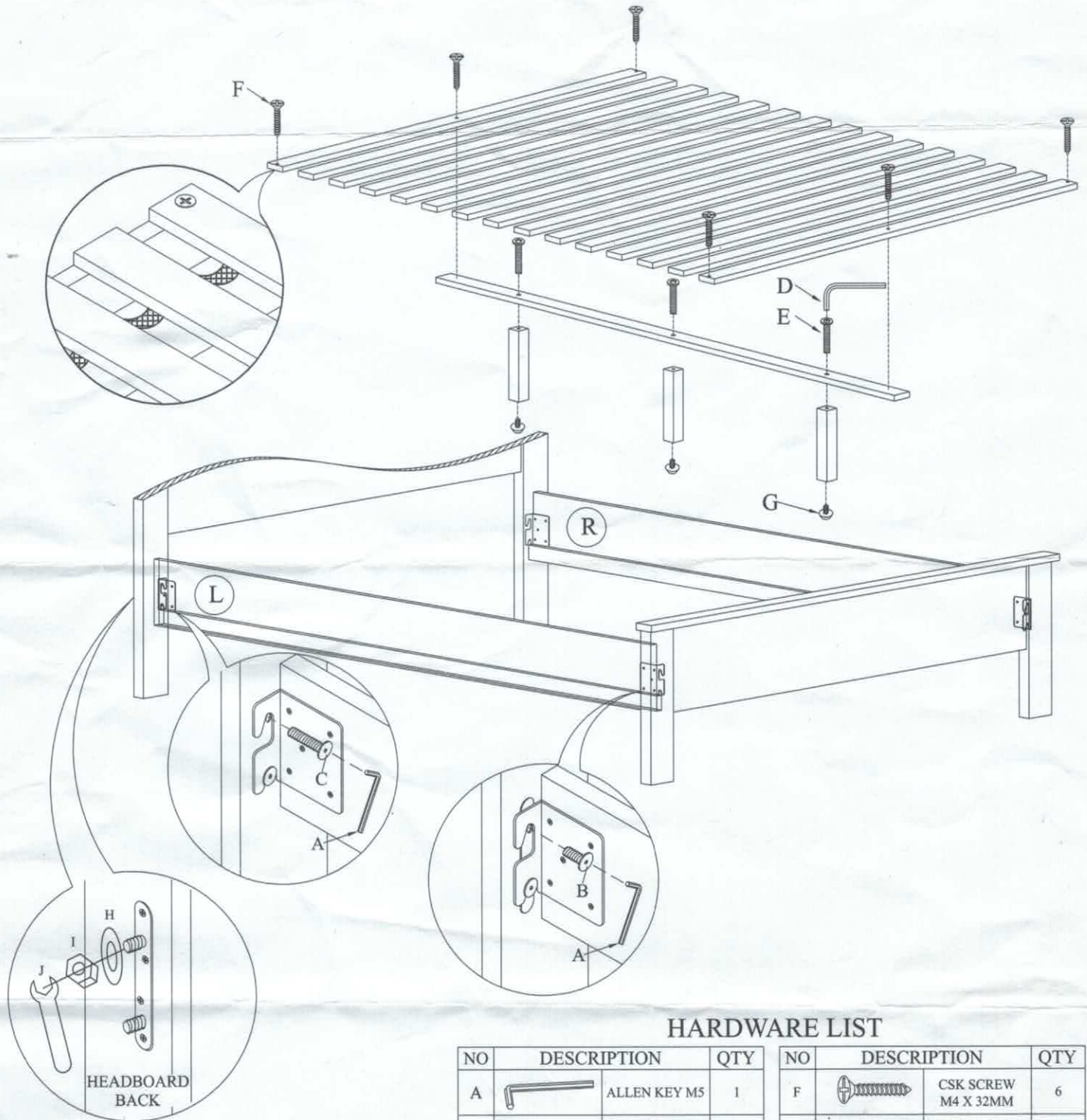









## ASSEMBLY INSTRUCTION

**Thank you for purchasing this quality product. Please check all packing material carefully which may have come loose inside the carton during shipment. Identity and count all parts referring to the Part List below.**



### HARDWARE LIST

NO	DESCRIPTION	QTY	NO	DESCRIPTION	QTY
A	 ALLEN KEY M5	1	F	 CSK SCREW M4 X 32MM	6
B	 JCB BOLT M8 X 20MM	4	G	 ADJUSTABLE LEG	3
C	 JCB BOLT M8 X 40MM	4	H	 M8 WASHER	4
D	 ALLEN KEY M4	1	I	 M8 HEXAGON NUT	4
E	 JCB BOLT M6 X 30MM	3	J	 WRENCH	1