

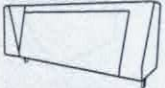







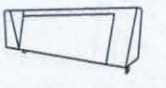

Assembly instruction

(CHAISE IN LEFT ARM FACING USE)

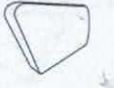
A  SOFA BACKREST 1PC	B  SOFA BACKREST 1PC	C  CHAISE BACKREST 1PC	D  CHAISE BACKREST 1PC	E  LEFT BACK CUSHION 1PC
F  LEFT BACK CUSHION 1PC	G  LEFT BACK CUSHION 1PC	H  RIGHT BACK CUSHION 1PC	I  BACK CUSHION 3 PCS	J  LEGS 14PCS
K  Spacer 14PCS				

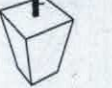
Please open the zip to find the legs and tods. Be sure to take out the legs and parts list from inside the box or zip underneath from the sofa&chaise and ottoman.

1: Fix the legs to the sofa &chaise and ottoman.

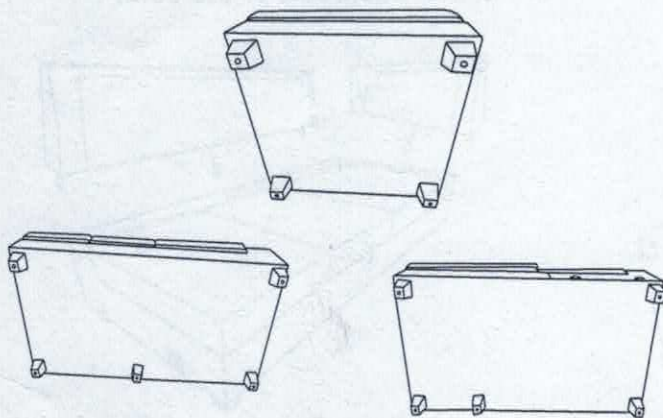

2: Fix the backrests to the sofa.

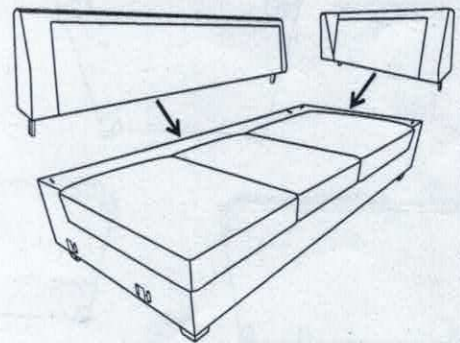

3: Fix the backrests to the chaise.

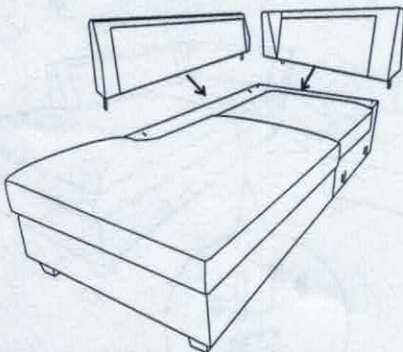

4: Fix the chaise to the sofa.

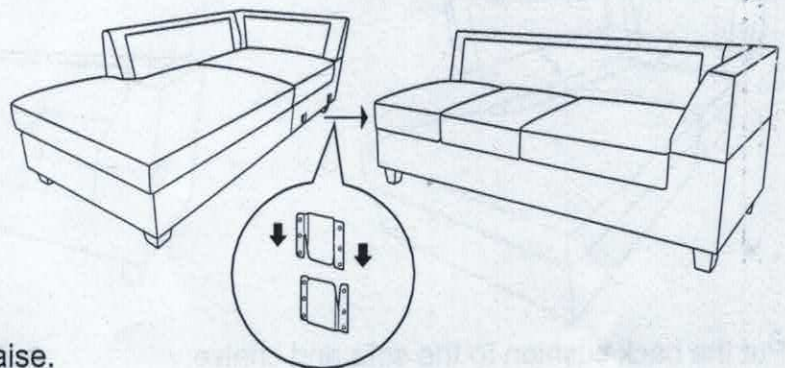

5: Put the back cushion to the sofa and chaise.

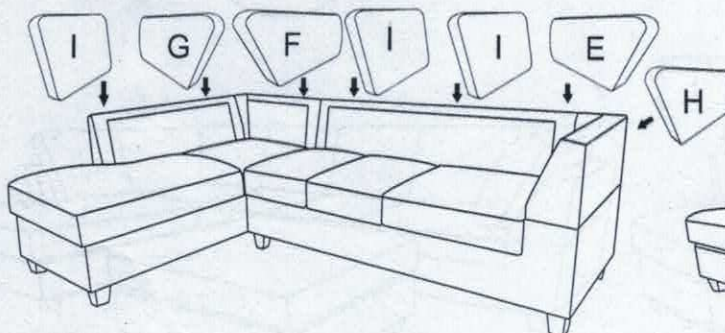









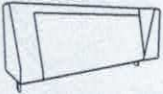

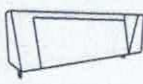
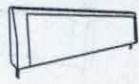
6: Finish !

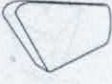

Assembly instruction

(CHAISE IN LEFT ARM FACING USE)

<p>A</p>  <p>SOFA BACKREST 1PC</p>	<p>B</p>  <p>SOFA BACKREST 1PC</p>	<p>C</p>  <p>CHAISE BACKREST 1PC</p>	<p>D</p>  <p>CHAISE BACKREST 1PC</p>	<p>E</p>  <p>LEFT BACK CUSHION 1PC</p>
<p>F</p>  <p>LEFT BACK CUSHION 1PC</p>	<p>G</p>  <p>LEFT BACK CUSHION 1PC</p>	<p>H</p>  <p>RIGHT BACK CUSHION 1PC</p>	<p>I</p>  <p>BACK CUSHION 3 PCS</p>	<p>J</p>  <p>LEGS 14PCS</p>
<p>K</p>  <p>Spacer 14PCS</p>				

Please open the zip to find the legs and tods. Be sure to take out the legs and parts list from inside the box or zip underneath from the sofa&chaise and ottoman.

1: Fix the legs to the sofa & chaise and ottoman.

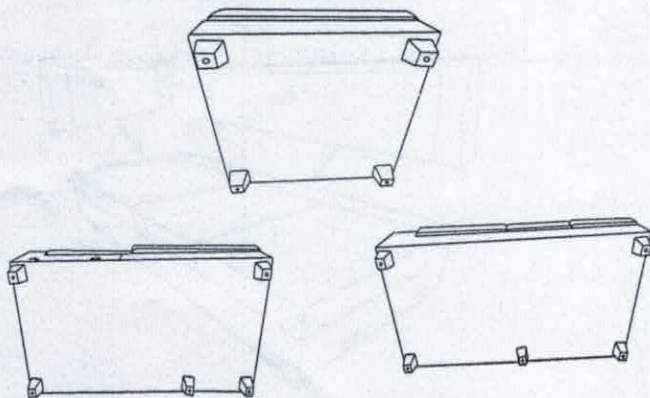

2: Fix the backrests to the sofa.

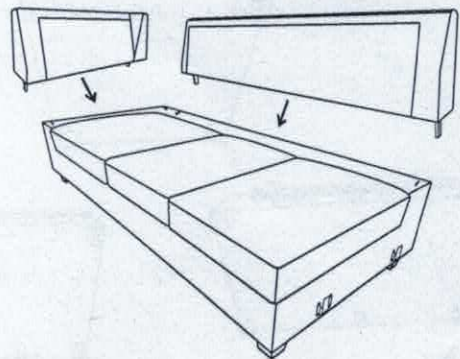

3: Fix the backrests to the chaise.

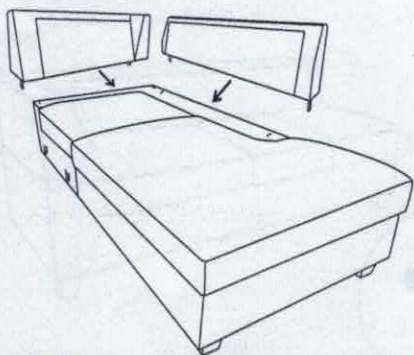

4: Fix the chaise to the sofa.

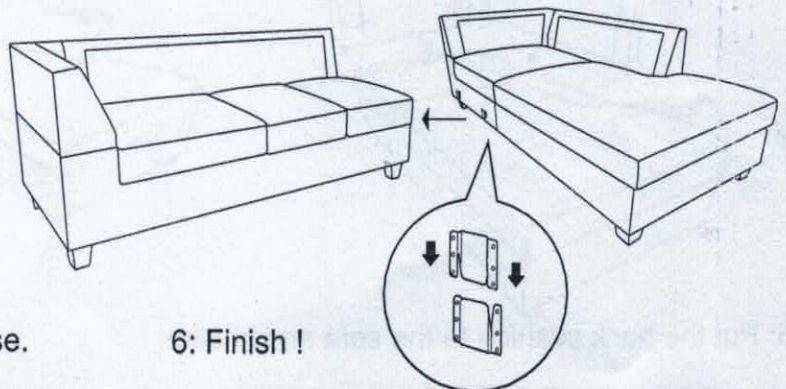

5: Put the back cushion to the sofa and chaise.

6: Finish !

